

POCKET DAWAH MANUAL



MISSION
DAWAH

WWW.MISSIONDAWAH.COM

f MISSIONDAWAH t MISSIONDAWAH

iera
ISLAMIC EDUCATION & RESEARCH ACADEMY

WWW.IERA.ORG

f IERAUK t @IERAUK

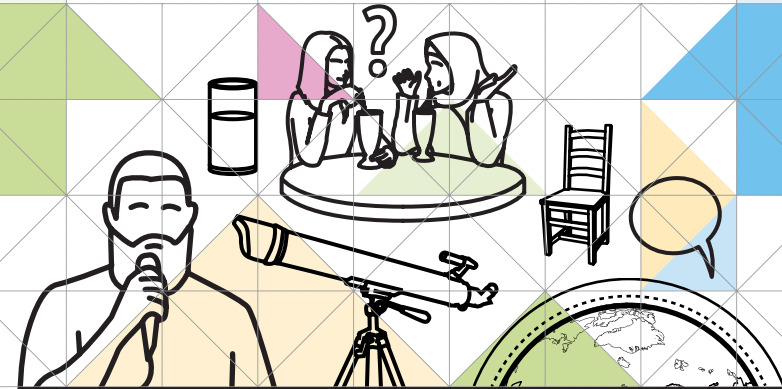

iera
ISLAMIC EDUCATION & RESEARCH ACADEMY

POCKET DAWAH MANUAL

MISSION
DAWAH



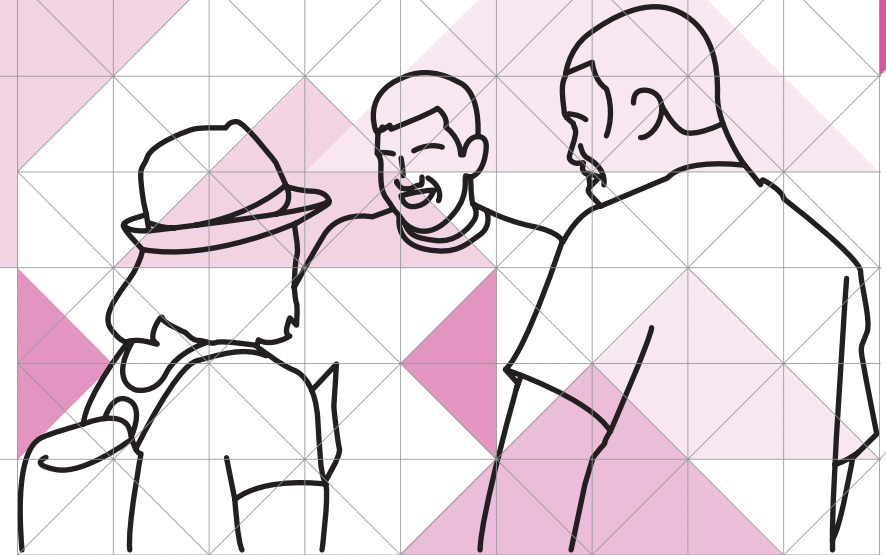

REVELATION

As we can see, the Quran contains an amazing amount of information which could not have been known or available to Mohammad (PBUH). The only conclusion is that it must have been from the Creator of the universe.

PROPHETHOOD

He did not have the psychological profile of someone who was a liar or deluded. Therefore, he was telling the truth and he is the Messenger of God.

CONTENTS

INTRODUCTION	2
IMPORTANCE OF DAWAH	2
INITIATION 1	6
INITIATION 2	10
GOD'S EXISTENCE	13
ONENESS	18
REVELATION	21
PROPHETHOOD	24
COMMON CONTENTIONS	26
SHAHADAH	28
COMMON CONTENTIONS TO SHAHADAH	31
AFTER SHAHADAH	32
DAWAH IN ACTION	34
CHECKLIST	36

INTRODUCTION

This booklet serves as a beginner's toolkit to understanding the importance of dawah and also how to give dawah. By the end of this booklet, you will have mastered a framework on how to convey the message of Islam effectively. This framework is like a skeleton which requires you to do further advanced studies in order to add meat to it.

IMPORTANCE OF DAWAH

Has the thought ever crossed your mind that your non-Muslim friends, neighbours, colleagues, acquaintances and even the local supermarket cashier will one day face Allah on the Day of Judgement and will be made to spend their eternal lives suffering in the depths of Hell?

What's even more profound is that YOU have a part to play in their fate. How? Let me explain...

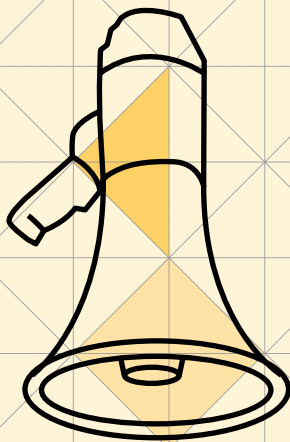

Allah created man for a noble purpose: to worship Him and lead a virtuous life based on His teachings and guidance. How would man know his role and the purpose of his existence unless he received clear and practical instructions on what Allah wants him to do? Thus Allah chose from every nation a prophet to convey His message to the people. The sole mission of every prophet and messenger was ultimately to guide humanity to paradise. However, the last of these prophets was Mohammad (PBUH) and there is no one else to come after him.

So the question arises: whose responsibility is it to guide mankind to paradise?

Allah answers this in the Quran where He says:

“And let there be [arising] from you a nation inviting to all that is good (Islam), enjoining what is right and forbidding what is wrong, and those will be the successful.” (Quran 3:104)

As Allah clearly states, it is our responsibility as Muslims to enlighten people about Islam and to continue spreading the message of Prophet Mohammad (PBUH). We learn from this verse that the one who adopts this noble duty and calls to Islam will be successful. In fact, taking the job of the prophets will not only result in satisfaction in this world, but also immense reward in the hereafter.

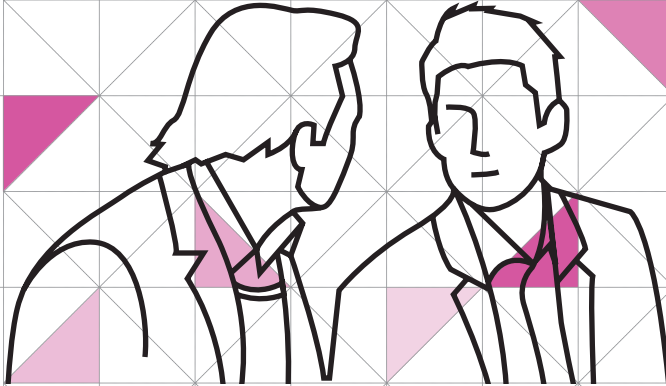

The Prophet Mohammad (PBUH) said:

“Whoever guides (another) to a good deed will get a reward similar to the one who performs it.” (Muslim)

So imagine you guide one person to Islam, and they start praying salaah, fasting, performing hajj and giving zakat. You would get the reward for all of that without ever doing the deeds yourself!

But it does not stop there. Imagine that person gets married and has children who also grow up to be pious Muslims who do good deeds; you would get the reward for that too!

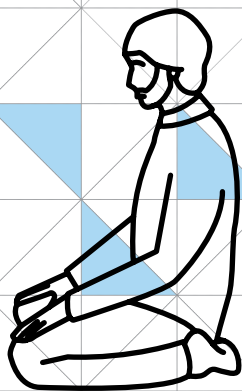

But wait, there's MORE! If they then have pious children who grow up to be practising Muslims and do good actions, then you will get the reward for all of their good deeds as well.

In fact, this could go on for generation after generation until the Day of Judgement. You could be standing on the Day of Judgement, witnessing crowds of people, all of whom are descendants of the person who became Muslim through your hands, enter into Paradise. Subhanallah the reward is unimaginable!

Allah says in the Quran:

“Indeed, Allah will not change the condition of a people until they change what is in themselves.” (Quran 13:11)

So making dawah a key part of your life defines who you are, which will have an immensely positive impact on you and the Ummah.

My dear brothers and sisters, let us not delay our responsibility any longer. It's time for us to step up to the mark and perform the duty of dawah commanded by Allah.

This booklet will guide you through some simple steps to giving effective dawah, so that you can help bring the light of Islam into someone's life inshaa'Allah.

THE GORAP APPROACH

An effective structure to introduce the foundations of Islam is the GORAP, which stands for:

G **GOD'S EXISTENCE**

O **ONENESS**

R **REVELATION**

A **AND**

P **PROPHETHOOD**

The GORAP method allows you to control your conversation and avoid difficult situations. It allows you to take the non-Muslim on a journey that reveals some of the compelling reasons for Islam being the truth. To learn the GORAP effectively, practise on a friend or a member of your family first. But before we go into the GORAP we need to look at how to initiate a dawah conversation.

INITIATION ONE

During dawah conversations, you are likely to be asked uncomfortable questions relating to topics such as terrorism, hijab, homosexuality and polygamy. We have to think about the most effective way of dealing with such questions.

Trying to answer EVERY uncomfortable question would most likely lead to an endless loop of argumentation, resulting in nothing more than a splitting headache!

The issue is that the non-Muslim does not understand the answers to the questions in the same way as we do. It is like they have a pair of red filtered glasses on and we are trying to persuade them that the sky is blue. But when they look at the sky, all they see is red!

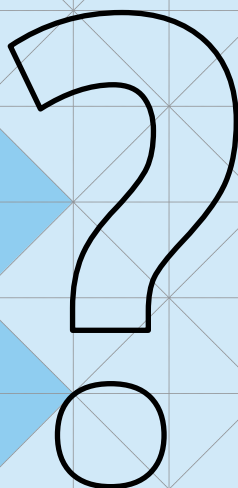
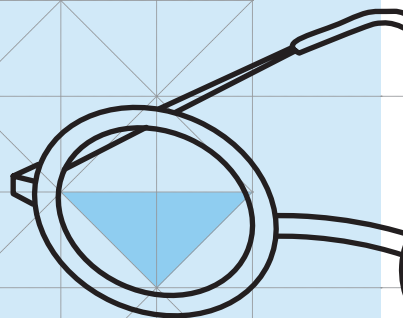

So even if you give them the most persuasive logical reasons as to why the sky is blue, they will still say it's red. So the most effective way to show that the sky is blue is to first get them to take off their red filtered glasses so they can see what you see. In other words, instead of answering the question, you direct them to the foundations of Islam and show how you know Islam is the truth.

So the most effective way to respond would be to direct the uncomfortable questions to the GORAP.

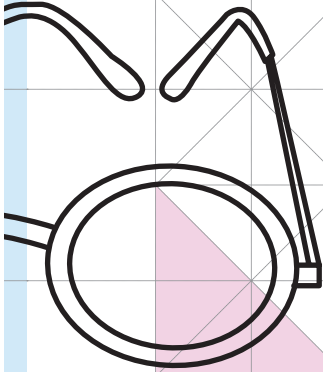
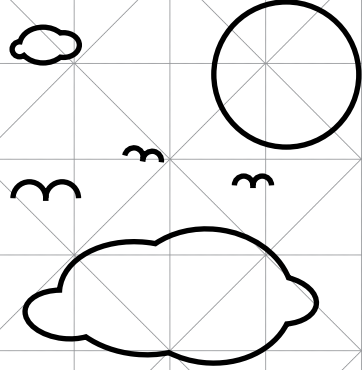
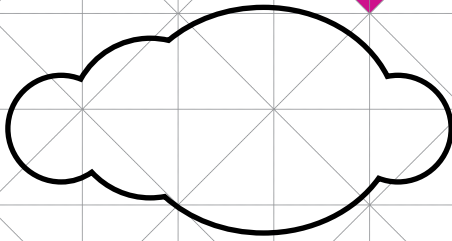

As we know, Islam is the truth and Allah is Al-Hakeem, the All-Wise. Decisions of all issues and matters belong only to Allah, the Lord, who knows everything. Whereas we, as human beings, have limited knowledge and must therefore submit to and depend on Allah.

So the simple explanation for why we do things in the name of Islam is because Allah commands it. And we follow it because we know that it is the truth. In order for the non-Muslim to understand this, we must first convince them of the rational foundations of Islam using the GORAP method.

If we get them to agree that Islam is the truth, they would understand that whatever comes from the truth is the truth! Even if God was to say that we have to roller skate on Tuesdays or wear leather jackets on Fridays, we would have to do it as God knows us better than we know ourselves.

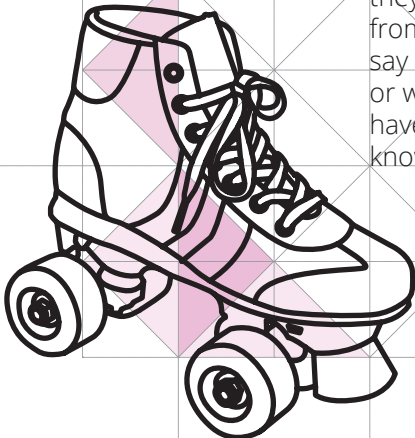

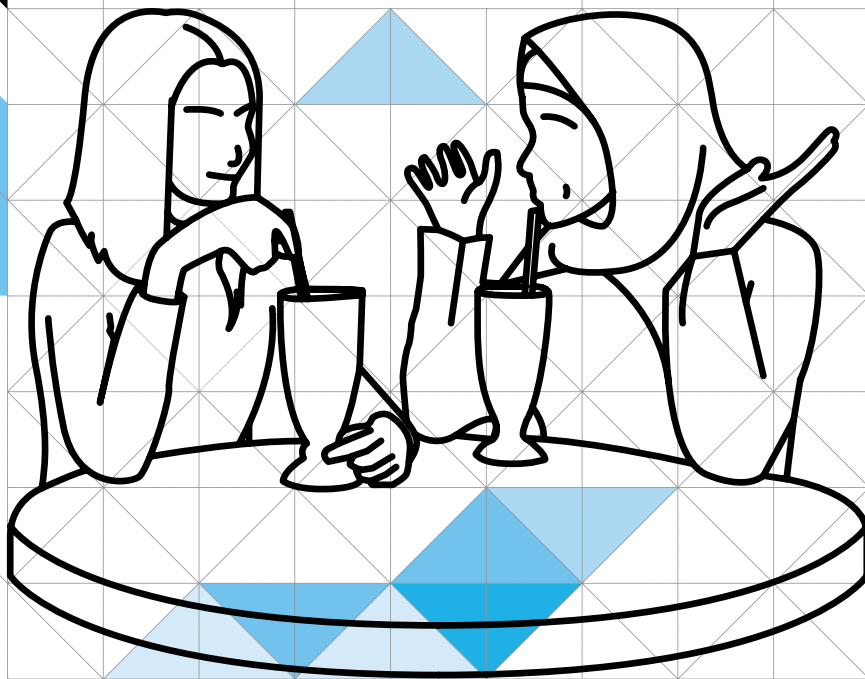

Here is an example of how to direct an uncomfortable question to the GORAP:

Kate: Hi Fatima, it's so hot! I don't know how you can wear that head scarf, it must be like torture! Why do you wear it anyway? I find it quite pointless and restricting.

Fatima: Kate, I totally understand why you would think that. In fact, I used to think the same thing before I used to wear it, so I really appreciate you asking me. But for you to truly understand why I wear the head scarf, you must first understand the foundations of Islam. Do you have a few minutes for me to explain this?

Kate: Yes sure.

In this example, Fatima was very empathetic rather than being defensive, and was able to create the avenue for her to go into the GORAP.

SUMMARY

How to direct an uncomfortable question to the GORAP

1. Acknowledge the question

"That is a good / important question. Thank you for asking me."

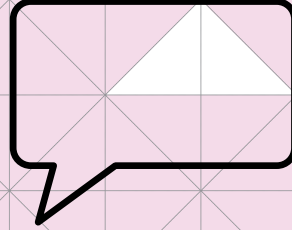

2. Direct the conversation to the GORAP

"For you to truly understand why I wear the head scarf, you must first understand the foundations of Islam."

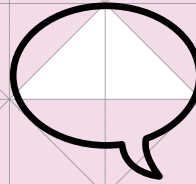

3. Get agreement

"Do you have a few minutes for me to explain this?"

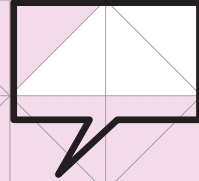

An important point here is that you can answer the question if you have the ability, as long as you then direct the conversation to the GORAP. You may get questions such as "Why are all Muslims terrorists?" You would then explain that Islam does not promote violence or allow innocent killing, but for them to truly understand what Islam teaches they must first understand the foundations of Islam.

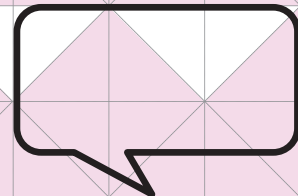
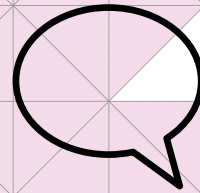

INITIATION TWO

A dawah conversation can be initiated anywhere by simply asking the right type of questions. Firstly, let's look at how you can start a dawah conversation during street dawah.

- 1) Walk in front of a non-Muslim and hand out the initiation material.
- 2) Ask them a series of open-ended questions to start engaging in dialogue.

An example of this is:

Excuse me, what do you think is the purpose of life?

Do you follow a faith? (If yes, then why follow that faith?)

Do you believe in a creator of our universe? (If yes, then why, and if no, why?)



Once they are engaged in the conversation, stop for a moment, introduce yourself, ask their name and shake hands if they are of the same gender. It is important to create trust and friendship early on.

- 3) Once you have built rapport, you can then direct this conversation to the GORAP.

Let's take another example of how to give dawah on the bus:

Wasim: Hello, do you mind if I sit there?

Man: Oh sure, please sit down.

Wasim: Thank you very much. *(Smiled at man)* I'm glad I got a seat; I would not have wanted to stand up for half an hour.

Man: *(Laughs)* Yes it's really busy around this time. Everyone is going back home from work.

Wasim: Yes, you're right. Are you from around here?

Man: No, I just work here.

Wasim: Oh I see. I'm studying here at the university.

Man: I used to go the university here too.

Wasim: Really, what did you study?

Man: I studied medicine. I'm now a doctor.

Continued on next page...

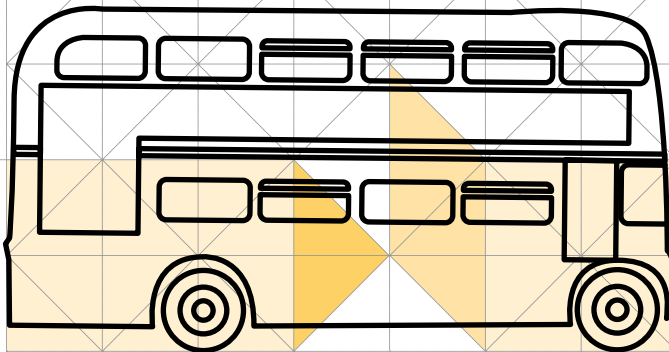

Wasim: Really? I'm doing the same thing! Just to let you know my name is Wasim. *(Smiles and shakes hand)*

Man: Hi Wasim, my name's David.

Wasim: Nice to meet you David. I know this is random and a bit out of the blue but can I get your opinion on something I have been thinking about lately?

David: Sure, please go ahead...

Wasim: How do you think the universe came into existence?

David: Umm, I am not too sure. I have never really thought about it!

SUMMARY

How to initiate a dawah conversation:

1: Build conversation by asking questions

"What is your name?"

"Where are you from?"

"What do you do for a living?"

2: Direct the conversation to a dawah conversation

"Can I get your opinion on something I have been thinking about lately?"

3: Initiate the GORAP

"How do you think the universe came into existence?"

"What do you think happens after we die?"

"What do you think is the purpose of life?"

GOD'S EXISTENCE

Once they have answered your questions, you can direct the conversation to God's existence by doing the following:

- 1) Summarise the answers they gave to your question.
- 2) Direct the conversation to God's existence by saying the following:

The most important question to first address is do we have a creator of our universe? Have you ever considered the following...

- 3) Two Quranic arguments for God's existence.

1. BEGINNING OF THE UNIVERSE

"Or were they created by nothing, or were they the creators [of themselves]? Or did they create the heavens and the earth? Rather, they are not certain." (Quran 52: 35-36)

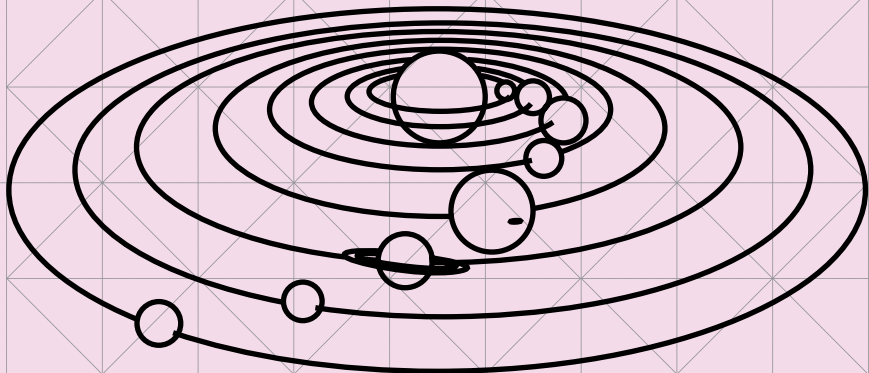

A) The universe had a beginning.

Science has discovered that the universe is expanding, and if we were to reverse this expansion, the universe would shrink down to nothing at all. Scientists do not know what was before the Big Bang, however one thing they do agree upon is that the universe is not eternal and had a beginning.

B) How did the universe come to exist?



Did it come from nothing?

From nothing, nothing comes. For example, if you heard a loud bang, you would never assume it just came from nothing. Or would a pink elephant just pop out from nothing into your living room? Obviously not! So the universe could not have just come out of nothing.



Did it create itself?

This is irrational because that would require it to be in existence and non-existence at the same time. It is like saying a mother gave birth to herself!



Or does it have a creator?

This is the most logical and rational conclusion.

C) The creator is powerful as it created the universe.

When we observe the planets, solar systems, galaxies, stars and everything else in the universe, this indicates that the creator must have an amazing amount of power and ability to be able to put the universe into existence.

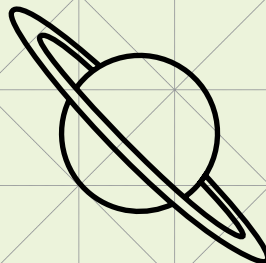

ORDER IN OUR SOLAR SYSTEM

"Indeed, in the creation of the heavens and the earth and the alternation of the night and the day are signs for those of understanding."

(Quran 3:190)

SIMPLIFICATION:

- **A) Anything that is ordered indicates intelligence.**

For example, if you were walking on a beach and saw the word 'hello' written in the sand, you would conclude that there is an intelligence that wrote this because the letters are ordered. You would never assume it happened by chance.

Or if you woke up in a factory and saw all the systems and machines manufacturing jeans, you would naturally conclude that there is an intelligence that manages this factory because it has order.

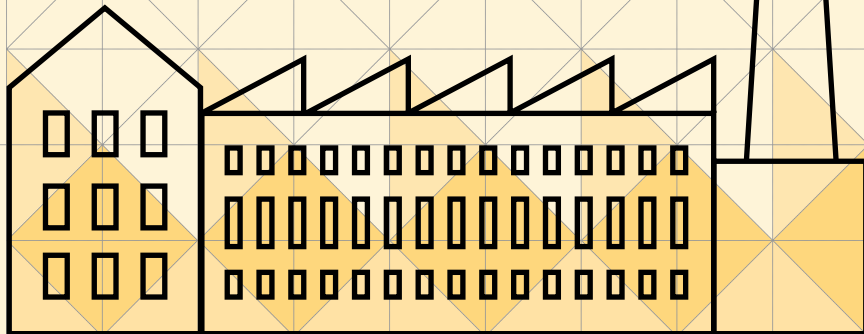
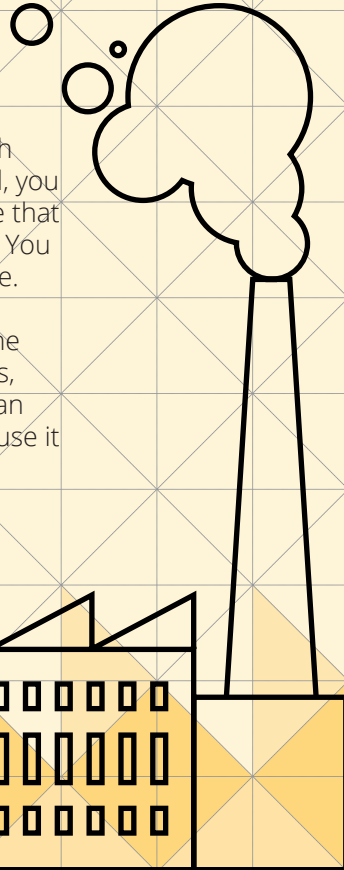

■ **B) Our solar system is highly ordered with intricate systems, laws and patterns which indicate that there is an intelligent designer.**

Let's look at some examples of our ordered and perfectly balanced solar system:

The sun's distance from the earth

The sun is at a perfect distance from the earth. If the sun was slightly further away, we would freeze and if it was any closer we would burn.

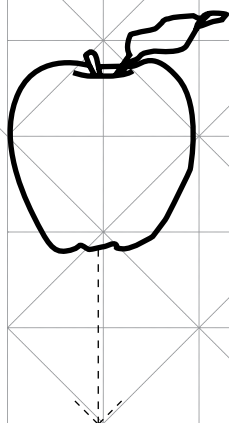

Gravity

If the gravitational force was altered, this would have a massive effect on our existence.

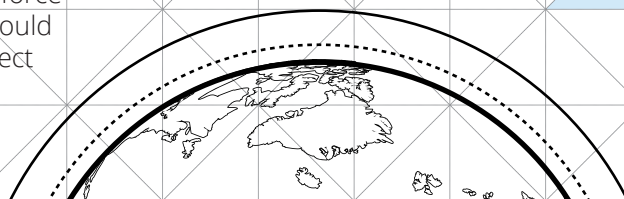
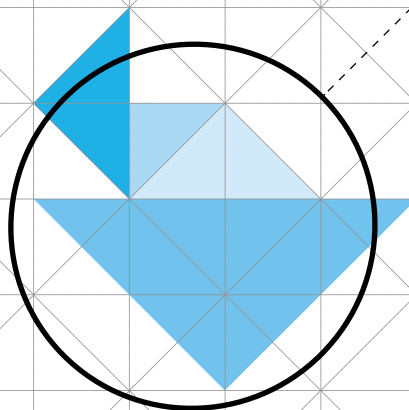

Ozone layer

If we did not have an ozone layer protecting us, we would be dramatically affected by the sun's harmful rays.

Earth's axis

If the axis of the earth was altered, this would create chaos and our earth would be uninhabitable.

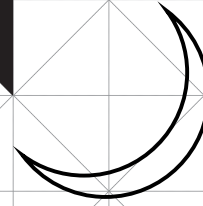
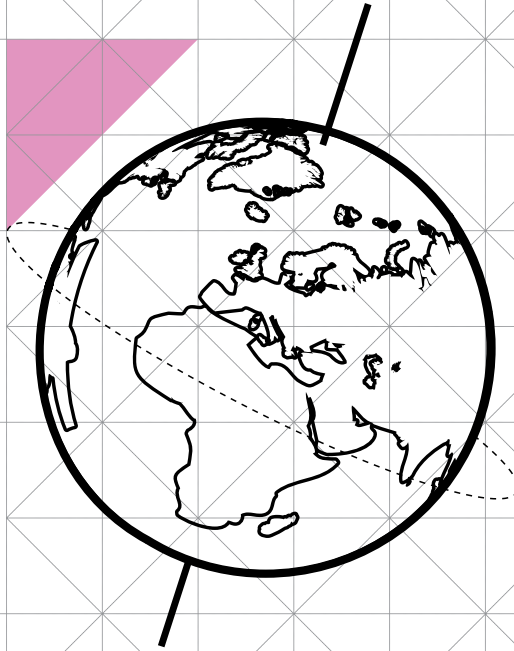

Size of the sun, earth and moon

If the size of the Sun or Earth was different, we would either be too hot or too cold. If the moon was a different size or did not exist, it would affect the gravitational force which stabilises the earth's axis. This would have a huge effect on our seasons and would increase the speed of the earth's rotation so that one day would only be a few hours long.

■ C) The order in our universe indicates the intelligence of the creator!

CONCLUSION:

From the two arguments above we can conclude that the best explanation for our existence is that there is a creator of our universe who has an amazing amount of power and intelligence.

ONENESS

Say, "He is Allah, [who is] One, Allah, the Eternal Refuge. He neither begets nor is born, nor is there to Him any equivalent." (Quran 112)

It is important for the non-Muslim to agree that the creator is different from creation, as that negates all other false concepts of who the creator is, such as Jesus or an idol. This can be done by asking the following questions:

■ A) Is the creator the same or different from creation?

If they agree that the creator is different, this negates all religions that say that God is within the creation.

It is evident to see that the nature of the creator is different from the creation. The creator has the power and ability to put this universe into existence, including all of the intricate laws, systems and planets. Whereas we as humans cannot even create a fly!

Also, when we make a chair or a table, we do not become the table. We are distinct and different from what we make. Similarly with the creator, it would be irrational to say that the creator created us and then became us or part of His creation.

However, if the creator is within the creation, this would mean that we have more creation!

The creator would need a creator, and then the creator of the creator would also need a creator. And you would end up with an infinite chain of creators.

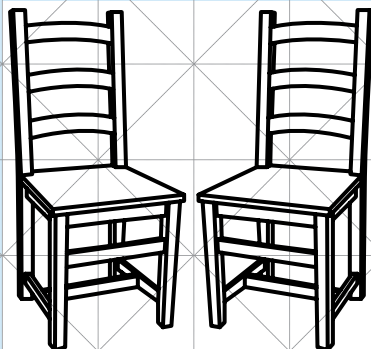

■ B) Can we have an infinite chain of creators?

Imagine you are in a car park and you hear an echo saying "HELLO... HELLO... HELLO!" Would you assume that this echo is eternal? You wouldn't because you know it must have started somewhere. In the same way, we cannot have an infinite chain of creators, because it must have started somewhere by a creator that is uncreated.

Another example is if a man knocked on your door and said that his car has broken down and he needs you to help push the car to restart it.

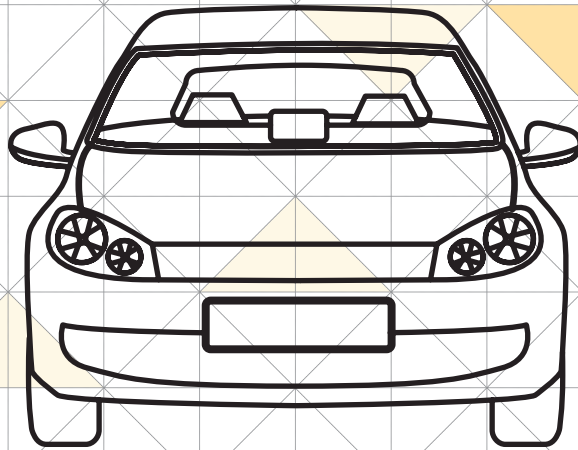

And you say that you will only help if your neighbour helps because the car is heavy. But your neighbour says they will only help if their neighbour helps. And your neighbour's, neighbour's, neighbour says they will only help if their neighbour helps! If this process of neighbours asking neighbours went on forever, would you ever help the man to move his car?

No, you wouldn't!

Now let's apply this principle to our scenario of creators creating creators going on forever. In the same way that the man's car would not restart or move, similarly, the universe would not have been created. So for the universe to be in existence, we could not have an infinite amount of creators and instead would need a creator who is eternal. This answers the common question of who created God.

C) God's Oneness

The order in the creation is evidence of God's oneness. This is because more than one creator would cause chaos within the creation. For example, if there are two CEOs of a company, they will both disagree on decisions, which will bring the company into chaos.

When we look at the stories of the ancient Greek gods, they would often go into war with each other.

However, as the universe is in order, this is evidence that the creator is one. As Allah says in the Quran:

“Had there been within the heavens and earth gods besides Allah, they both would have been ruined. So exalted is Allah, Lord of the Throne, above what they describe.”

(Quran 21:22)

CONCLUSION

The creator is uncreated because we are not able to have an infinite chain of creators. Due to this, we can conclude that the creator is unique, different from creation, self-sufficient and one.

Another proof of the oneness of God is the order within the creation. If there were more than one god, we would have seen disorder within the creation. As we have order within the creation, the creator must be one.

REVELATION

The next step is to show that the Quran is the revelation from the creator.

■ A) Need for revelation

As the creator has created us and provided food, clothing and oxygen, would it not make sense that He also provides for our spiritual needs, offers us guidance and explains the purpose of our creation?

The creator has sent manuals to mankind to announce His presence and provide guidance. The final manual sent by the creator was the Quran, which was sent around 1400 years ago. The Quran serves as a compass for life. It offers us direction and allows us to understand why we exist. The guidance contained in the Quran enables all of us to live life in a way that God loves and is pleased with.

As the creator, God knows us best and is therefore best placed to guide us on how to function optimally. It is a bit like when you buy a mobile phone with a manual describing its functions. The Quran is therefore a handbook, from the Creator to the created, and is not something written by man.

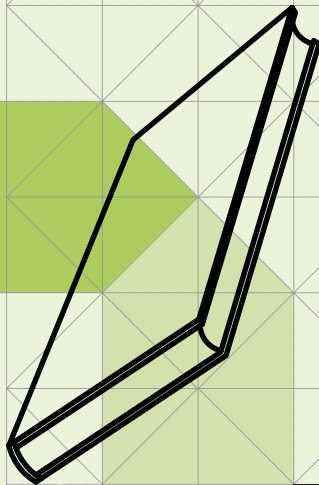

However, anyone can write a book and claim it is from the creator. So a book that is truly from the creator would have some evidence to show it is from the creator and not from man.

We will now look at some of the compelling evidence that shows the Quran must be from the creator and not merely written by a human.

■ B) The amazing Quran

□ Preservation

“Verily, it is We who have sent down the Quran and surely, We will guard it (from corruption)” (Quran 15:9)

One of the miraculous aspects of the Quran is that it has been preserved through oral tradition. The original texts of most former divine books were lost altogether, however, the Quran exists exactly as it was revealed to the Prophet (PBUH).

The Quran was memorised by the companions of the Prophet Mōhammad (PBUH) who taught it to their students, who then taught it to their students, and this has gone on until today.

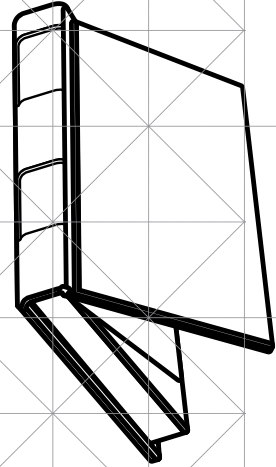

□ Science - Cosmology

“And the heaven We constructed with strength, and indeed, We are [its] expander.” (Quran 51:47)

The Quran talks about the expansion of the universe which was discovered in 1929 by Edwin Hubble. How did a book 1400 years old have this information? It must have been from the creator of the universe.

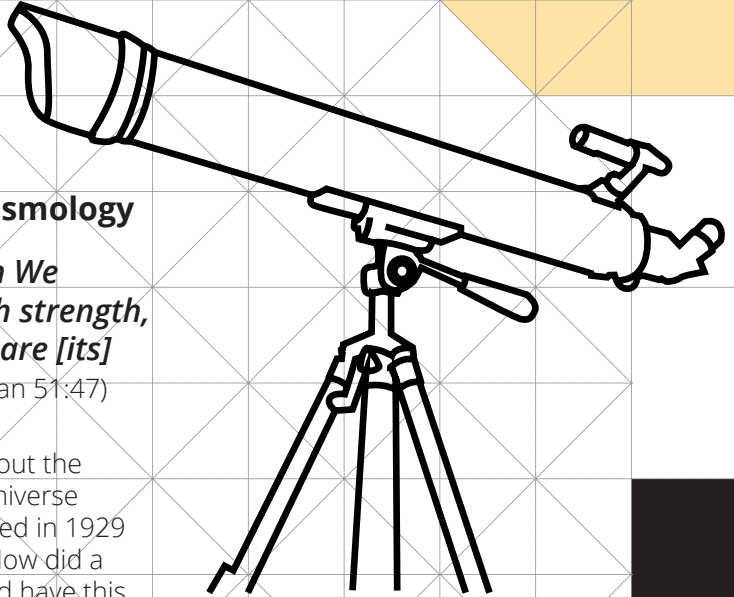

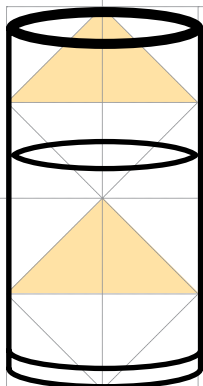

□ Origin of life

“We made every living thing from water? Will they not believe?”

(Quran 21:30)

The first thing scientists look for when trying to find life on another planet is water. This is because water is essential for all living things. Living things are made of cells and the majority of a cell is made from water. Mohammad (PBUH) did not have a microscope or any form of technology to know this. Therefore, this is another proof to show the Quran must be from the creator.

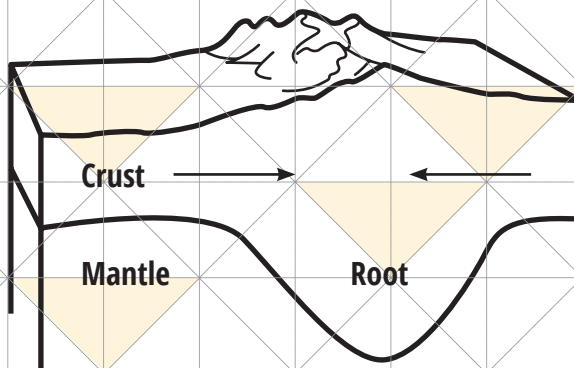

□ Mountains

“Have We not made the earth a resting place? And the mountains as stakes?” (Quran 78:6-7)

The Quran describes mountains as stakes, in other words having deep roots. Using modern technology, we have been able to confirm that mountains have large deep roots.

CONCLUSION:

As we can see, the Quran contains an amazing amount of information which could not have been known or available to Mohammad (PBUH). The only conclusion is that it must have been from the Creator of the universe.

PROPHETHOOD

The next step is to show that Mohammad (PBUH) was a truthful prophet from the creator.

A) Introducing prophets

The creator chose prophets to announce the presence of the creator and to be an example for how we should live our lives. All the prophets including Abraham, Moses, Jesus and Mohammad, peace be upon them all, had the same message.

Mohammad (PBUH) was known for having an amazing character even before claiming prophethood. In a time where corruption was widespread, Mohammad (PBUH) would not engage with the evils that the society was immersed in. He would look after the orphans and elderly and would help to improve the society. The people knew him as someone who was trustworthy and honest.

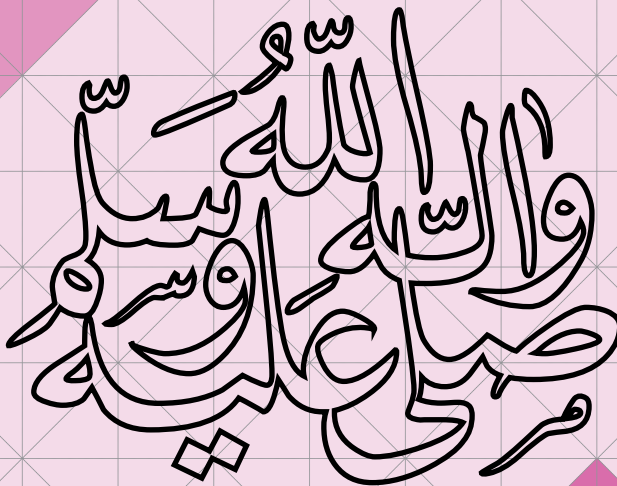

B) Was Mohammad (PBUH) a real prophet?

Was he:



A liar?

His enemies considered him to be honest and trustworthy and he had the nickname of Al-Ameen (the Trustworthy).

A liar normally lies to get some worldly gain. Mohammad (PBUH) was offered power, wealth and women by the chiefs of Makkah, but refused them all for the message he brought and as a result suffered great hardships.

Does this sound like the profile of someone who is a liar to you?



Deluded?

Some could claim that he actually thought he was a prophet but in reality he was not.

This is very problematic because a deluded person could not have produced something as miraculous as the Quran.



Speaking the truth?

CONCLUSION

In conclusion, Mohammad (PBUH) did not have the psychological profile of someone who was a liar or deluded. Therefore, he was telling the truth and he is the Messenger of God.



COMMON CONTENTIONS

I have never seen God. Therefore he does not exist...

Have you ever seen your great, great, great, great, great grandmother? We don't have her grave or DNA and have never seen her. In fact, we have no testable evidence that she ever existed. But can we deny that she existed just because we have not seen her? No.

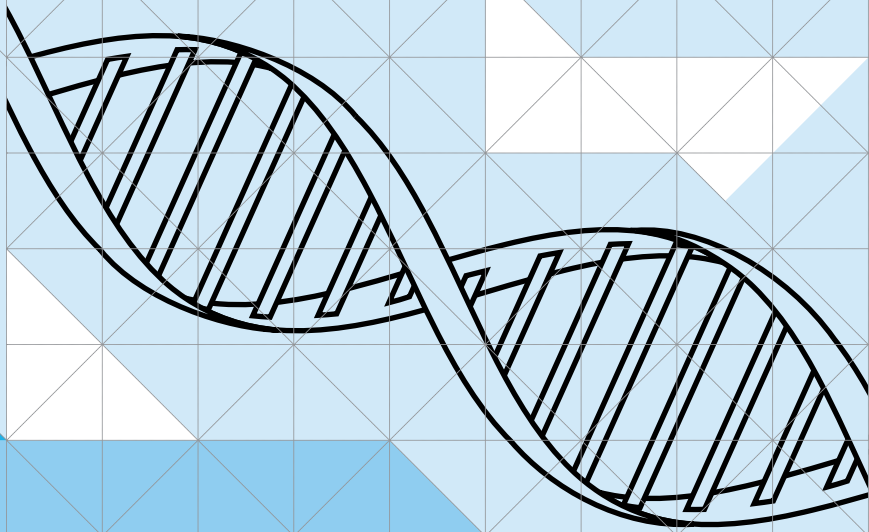

But does not evolution disprove God?

No it does not. In fact, it does not even come into the discussion because we have been talking about how the universe came into existence. Evolution does not give answers to how the universe itself came into existence.

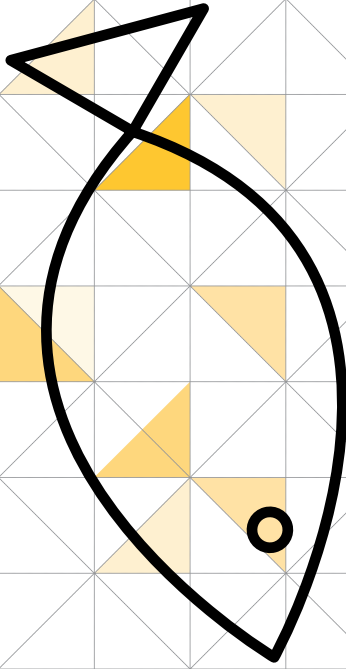

Jesus is the son of God

What do you mean by Son of God? Do you mean that God had intimate relations with a woman? I do not think that is what you mean.

Think about if I were to say to you that I have a fish called Flappy, who is my son. Flappy eats at the table, has his own room and the adoption papers are coming next week.

What would you think? That I am crazy, right?

That is because the fish has a different nature to me. But the creator also has a different nature to Jesus, so it does not make sense that Jesus is the son of God.

There is so much evil and suffering in the world so how can God exist?

In fact, this argument does not disprove God in any way, rather it is questioning the reason why God allows there to be pain and suffering. If you are an atheist, then you believe this is the only life you get and want to make the most of it.

However, just because you may perceive something as evil or suffering does not mean that it actually is. For example, if a man stabbed babies with needles, you would perceive him as evil and that the baby is suffering. However, a doctor may need to give injections to babies to save their lives. In the same way, God tests us so we turn to Him. And if we get closer to God we get rewarded in the hereafter.

SHAHADAH

It's now time to go for GOLD and get the shahadah!

We need to make the invitation to Islam, but before that, we need to make it clear what it means to become a Muslim.

A) Summary of Islam

Give a summary of the GORAP and get agreement from them on each point if they agree.

Once you have agreement on the beliefs of a Muslim, you then want to ask them if they know how to become a Muslim. They are likely to say no, but either way, you can then introduce the basic 5 pillars of Islam.

1

1. Testimony of faith

"To become a Muslim, you have to accept and testify that there is only one God worthy of worship and that Mohammad (PBUH) is a prophet from God, which you have already agreed within our conversation. Once you have made this testimony you have entered into the fold of Islam and agreed that you will now live your life according to God's guidance, which is the Quran and the example of the Prophet Mohammad (PBUH)."

2. Praying

"Once you have entered into Islam you must start establishing the 5 daily prayers. In the same way that we need to eat three times a day for breakfast, lunch and dinner, similarly, our soul also needs to be nurtured through the 5 daily prayers. This is something that God commanded all the prophets in the past to do. However, Allah makes it very easy, so if you cannot pray standing, you can pray sitting, and if you can't pray sitting, you can even pray lying down."



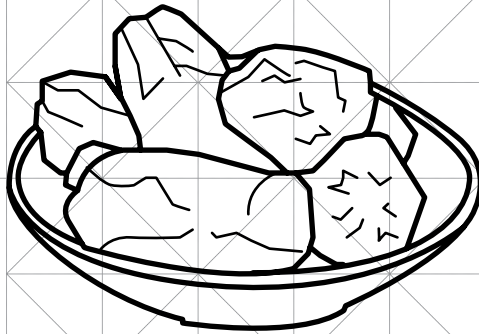

4. Charity

"You will need to give 2.5% of your annual savings to charity. This will encourage generosity and help others. If you cannot afford to give this, then you receive the charity!"

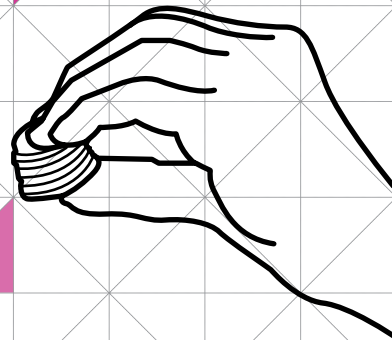
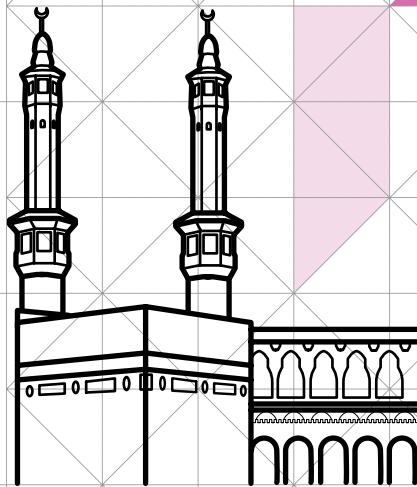

3. Fasting

"You also need to fast in the month of Ramadan, which will strengthen your soul against desires and draw you closer to your creator."

5. Pilgrimage to Hajj

"If you have the ability and finance then you must go for the pilgrimage at least once in your life. This is where people from all around the world, regardless of colour or status, come together and worship the one creator."

"So the purpose of life is to follow the creator's guidance which is the Quran and the example of the Prophet Mohammad (PBUH)."

■ B) Two paths

To add a sense of urgency, it is important to introduce the Day of Judgement, Paradise, Hellfire and death.

Day of Judgement

There will be a day when we will face our creator and we will be questioned on whether or not we lived our life according to His guidance."

Hellfire / Paradise

"For those who followed their own desires and lived their life the way they wanted, they will go to Hell forever. Those who followed God's guidance will be admitted into Paradise and will remain there forever."

Time/Death

"The reality is that this life is short and we can leave anytime. So we have to make that decision now whether we are going to follow the truth or not."

C) Ask for the shahadah

Are you ready to join the brotherhood / sisterhood of Islam?

As mentioned this is a testimony, in front of your creator, that you will spend your life as a Muslim following His guidance.

"Ash-shadu an laa ilaaha il Allah wa ashadu anna Mohammad rasoolullah."

"I testify that there is nothing worthy of worship except Allah and that Mohammad is the Messenger of Allah."

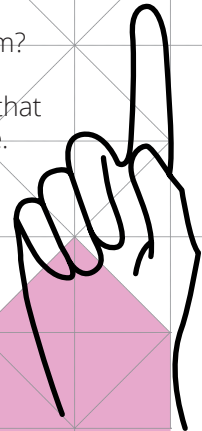

CONTENTIONS WITH SHAHADAH

My family will not be happy

The reality is when you are in your grave or facing your creator on the Day of Judgment, it will not be about your family, but it will be about you and your creator.

I need to fix up first

Becoming a Muslim does not mean you become an angel overnight. Becoming a Muslim is taking the first step to becoming a better person.

I need to study more

What more is it that you need to study? We can take out all the other religions because we have agreed they all don't make sense as they do not have a logical understanding of the creator.

In regards to studying more about Islam, I have given you an outline of the foundations, which shows what we believe and what we do. Anything else is just extra.

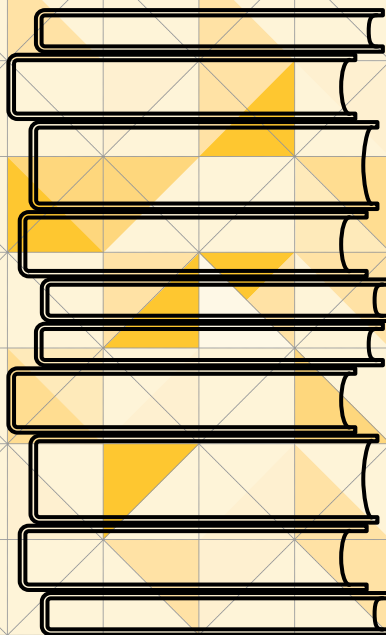

AFTER SHAHADAH

Imagine if a fisherman went out into the sea every day and worked for hours trying to catch fish. By the end of the day he had caught a bucket of fish, but every day by the time he got back home, all the fish had jumped out and he had no fish left. Would you agree that it would be a complete waste of his time and effort?

In the same way, it would be a waste of effort if you get many shahadahs but none of the people who have taken their shahadah become practising Muslims. If you think about it, Shaytan believes in Allah, he believes in the Quran and that Mohammad is the Prophet of Allah. But is he going to Jannah? No!

So what is the difference between Shaytan and a Muslim when they both believe in Allah and they both believe Mohammad (PBUH) is the final messenger? The difference is that the Muslim submits to Allah and follows Allah's guidance. The Muslim takes action and does not just keep it as a belief.

The key point here is that the ultimate goal is not the shahadah but Jannah.

So realise that it is YOUR responsibility to teach the new Muslim how to become a practising Muslim.

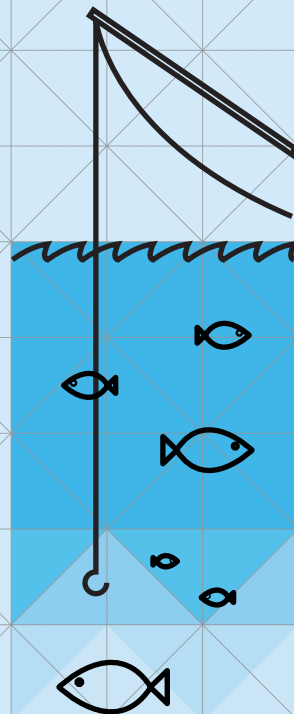

Here are some critical post-shahadah steps:

1) Teach them how to pray as soon as possible, ideally in their local mosque. Get them to establish their 5 daily salaah.

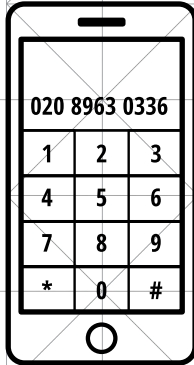
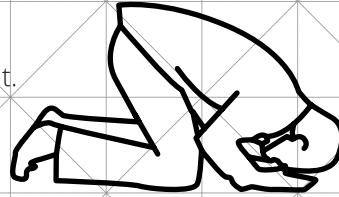

2) Swap contact details - contact them, take them out and get them to meet other brothers / sisters. Give them a taste of the amazing brotherhood / sisterhood in Islam.

3) Make sincere dua for them!

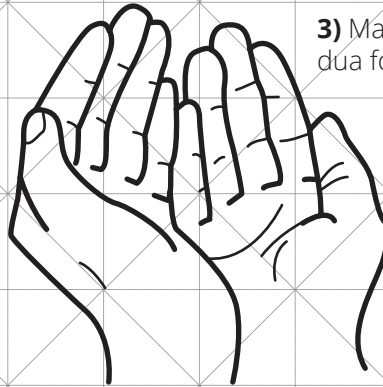

4) Warn them of the potential pitfalls of being a new Muslim, such as reading misinformation about Islam over the Internet or being rejected by family and friends.

5) Introduce them to Muslim Now:
www.muslimnow.com

MUSLIM
NOW

DAWAH IN ACTION

Now that you have mastered an effective dawah method, you need to put it into action. So think about how you can make dawah a key part of your life and create a mass movement of dawah in your community. Here are some ideas:

- Build a dawah team
- Start a dawah table
- Do one to one street dawah
- Speak to your neighbours
- Create videos
- Write articles
- Teach others the GORAP
- Deliver talks focused on the GORAP

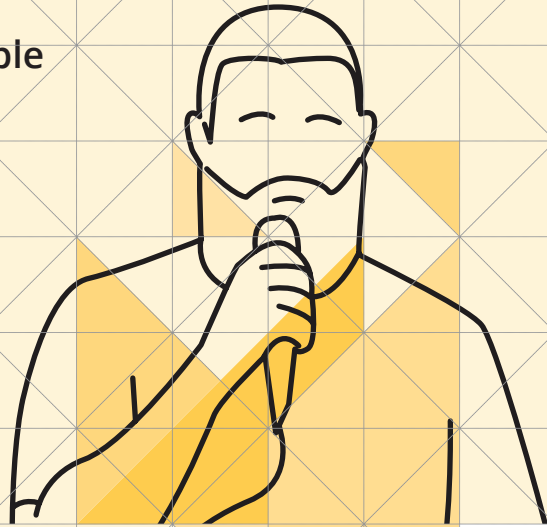

EXTRA RESOURCES

Books

The Quran

Every da'ee needs a solid every day relationship with the Quran.

The Man in the Red Underpants

A great book structured with the GORAP approach.

Websites

WWW.MISSIONDAWAH.COM

For extra dawah training and resources, visit the official Mission Dawah website.

WWW.ONEREASON.ORG

The One Reason website is tailored to effectively convey the message of Islam to non-Muslims.

WWW.MUSLIMNOW.COM

A website dedicated to welcome, empower and provide education for New Muslims.

WWW.IERA.ORG

Visit the official website for more information on the Islamic Education and Research Academy (IERA).

WWW.THEBIGDEBATES.COM

The Big Debates is a platform which seeks to build bridges of understanding and discussion between Western and Islamic thinkers.

CHECKLIST

Look back at this checklist after giving someone dawah to make sure you mentioned everything this booklet has taught you:



GOD'S EXISTENCE

We can conclude that the best explanation for our existence is that there is a creator of our universe who has an amazing amount of power and intelligence.



ONENESS

The creator is uncreated because we are not able to have an infinite chain of creators. Due to this, we can conclude that the creator is unique, different from creation, self-sufficient and one.

Another proof of the oneness of God is the order within the creation. If there were more than one god, we would have seen disorder within the creation. As we have order within the creation, the creator must be one.

